

Hudson Automatic Water Fill Valve

Installation Instructions

PACKAGE INCLUDES:

- Fill Valve
- Slide Plate with thumbscrew and 2 bolts
- Instructions for Use



CARE AND MAINTENANCE

- Regular pond maintenance such as removing debris from the skimmer basket/net will help the WFV operate more efficiently.
- Winter preparation – The WFV will not operate during extended freezing temperatures. Simply turn off the water supply to the unit and disconnect 1/4" tubing from the WFV. To remove tubing from the quick connect fitting, hold in the socket on the fitting and pull tubing out.
- Float must be in a flat vertical position to work.

NOTE

- Easy to Install, takes only a few minutes!
- Maintains a ponds proper water level
- Plastic housing protects float
- Fits all skimmer models and MicroSnorkel™

Features

The Hudson WFV includes fittings to connect to a 1/4 inch poly tubing. The 1/4 inch poly tubing can be trenched over to a standard water spigot or connected to an irrigation system by a professional irrigation specialist.

Installing the Hudson WFV

Tools needed for installation:

- 5/32 inch drill bit
- Phillips head screwdriver
- Adjustable wrench

Parts list for the WFV System

- Fill valve with quick connects installed
- Slide Plate with thumbscrew and 2 bolts
- Brass Quick Connect Water Spigot Fitting (sold separately, #07000).

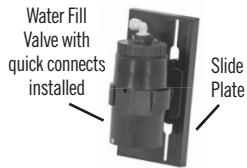

- 1/2" to 1/4" Irrigation Conversion Kit. Allows WFV to be connected to irrigation line. (sold separately, #01008)
- 1/4" x 100' Poly tubing (sold separately, #29470)

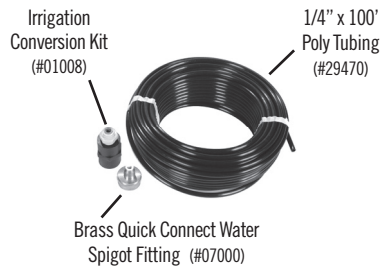

Skimmer Installation

- 1) Measure down 3" inches from the top of the Signature and Classic series for proper hole location. The second hole should be 1" over.
- 2) Drill two 5/32" holes at the locations marked.
- 3) Hold the WFV with slide plate assembly to the inside of the skimmer and thread the two screws from the outside through the holes drilled.
- 4) Lay the tubing through the cord relief and insert into the quick connect fittings. For Classic series, drill a 9/32" hole in the back wall to run the tubing through. Leave extra tubing inside the skimmer for adjustments. To remove tubing from the quick connect fitting, hold in the socket on the fitting and pull tubing out.
- 5) Bury the 1/4" poly tubing to water spigot and connect using adaptor.

- 6) Adjust the WFV. Final adjustments to the fill valve should be made while the pump is operating and the water in the pond is at the desired level. Simply loosen the thumbscrew and slide the unit up or down until the valve shuts off at the desired level. The valve will shut off 3/4"-1" from the bottom of the valve depending on pressure. **Note:** There will be a short delay in shut off the first time the valve is used while the control chamber fills with water.

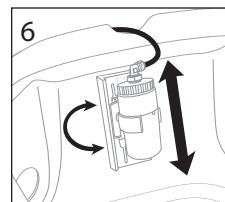
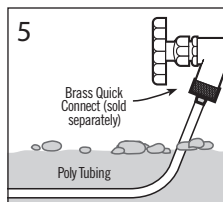
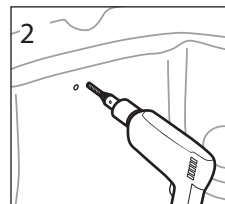
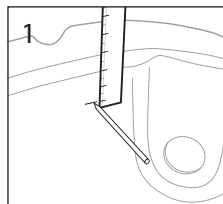
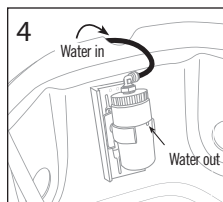
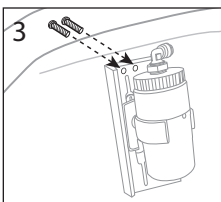

MicroSnorkel™ Installation

- 1) On the outside of the MicroSnorkel™, measure 2" down and at least 1" over for proper location. The second hole should be 1" over. (Picture with slide plate)
- 2) Drill two of 5/32" holes at the location marked.
- 3) Hold the slide plate assembly to the inside of the MicroSnorkel™ and thread the two screws from the outside through the holes drilled.
- 4) Run the tubing through the pipe discharge and insert into the quick connect fitting. To remove tubing from the quick connect fitting, hold in the socket and pull the tubing out.
- 5) Bury the 1/4" poly tubing to water spigot and connect using adaptor.

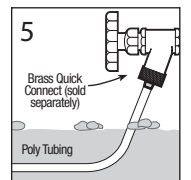
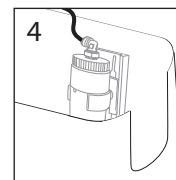
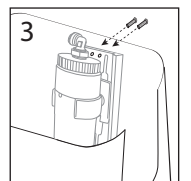
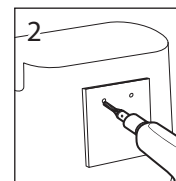
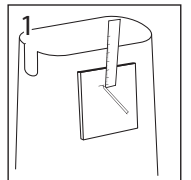

Made in USA for
Aquascape, Inc.
St. Charles, IL 60174 • Brampton, ON, L6T 5V7
www.aquascapeinc.com

PARTS AND TROUBLESHOOTING

- | | |
|---------------------------|----------------------|
| 1. 1/2" Valve Screen | 7. 1/2" Splash Guard |
| 2. Cap with Brass Threads | 8. Valve Body Insert |
| 3. Retainer Ring | 9. 1/2" Valve Body |
| 4. Diaphragm Strainer | 10. Screw |
| 5. Diaphragm Stem | 11. Shutoff Pad |
| 6. Control Diaphragm | 12. 1/2" Float |

Troubleshooting

Is your Hudson Valve not shutting off or leaking? If so, here are a few tips to fix it!

- Check to see if the valve screen(1) is still on, if so remove it. Sometimes the screen prevents the diaphragm stem(5) from moving up which creates the seal and stops the flow of water.
- Unscrew the cap(2) and check for any loose debris that may be in or around the area and remove. Debris could also prevent a tight seal and cause the valve to not shut off.
- There are two small access points for water to travel through that are very important in the correct function of the Hudson that sometimes can get clogged. The diaphragm stem(5) and valve body insert(8). To check the stem, unscrew the cap and pull the diaphragm strainer cap(4) off of the stem. Check the stem for a small hole at the tip. If you do not see a small hole take a small needle or pin and poke a hole in the tip to allow water through. **See figures B and C.** To check the valve body insert look at the valve body from the top. You will see a small hole in the middle that allows water through. Check to see if small debris got clogged inside. If so, take a small needle or pin and clean it out. You can also try blowing through the insert to clear it as well. **See figure A.**
- Water Pressure and flow are two factors that can also prevent the valve to operate correctly. If you have checked everything above and are using 1/4" tubing and are still having troubles, try running 1/2" line to allow more flow. You can also try opening the valve from the water supply all the way to make sure you are getting the most pressure and flow.

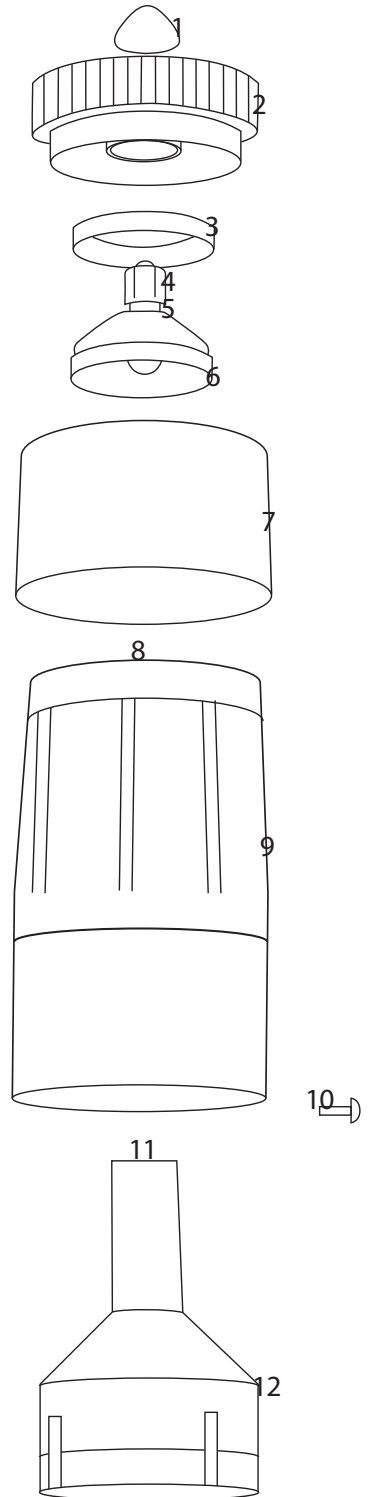
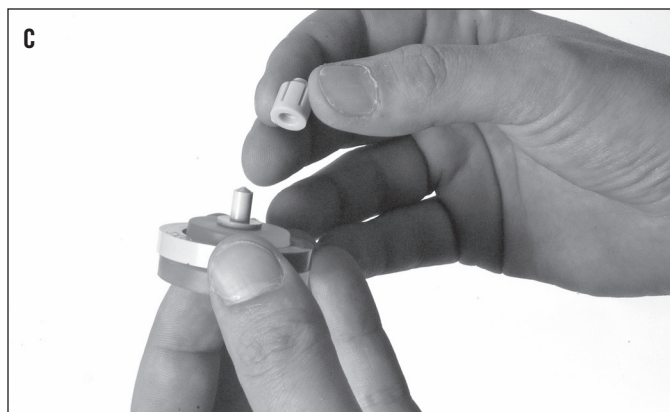
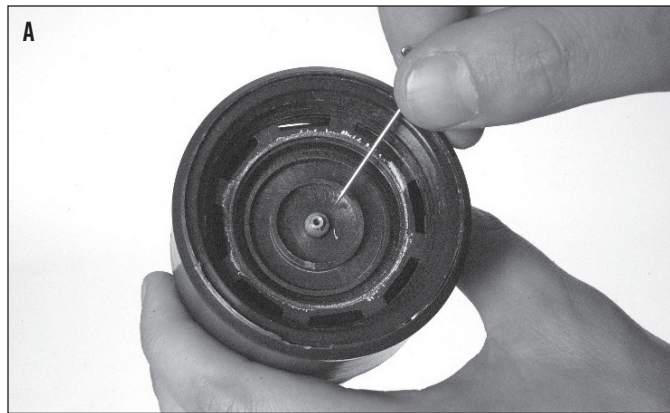

Line Drawing of Hudson Automatic Water Fill Valve